



JT015N120F7PD1E

主要参数 MAIN CHARACTERISTICS

I_c	15A
V_{CES}	1200V
V_{cesat_typ} ($V_{ge}=15V$)	1.8V

用途

- 辅助逆变器
- 电机传动
- 空调

APPLICATIONS

- Auxiliary inverter
- Motor Drives
- air conditioning

产品特性

- FS 技术
- 低通态压降, $V_{CE(sat)}$,
typ = 1.8V, $I_c = 15A$ and
 $T_c = 25^\circ C$
- V_{CEsat} 正温度系数
- 低开关损耗

FEATURES

- FS Technology
- Low saturation voltage:
 $V_{CE(sat)}$, typ = 1.8V, $I_c =$
15A and $T_c = 25^\circ C$
- V_{CEsat} with positive
Temperature Coefficient
- Low Switching Losses

封装 Package

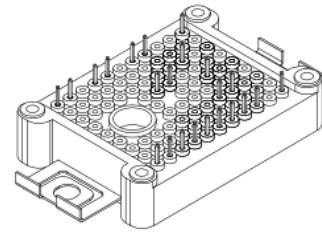

外形示意图

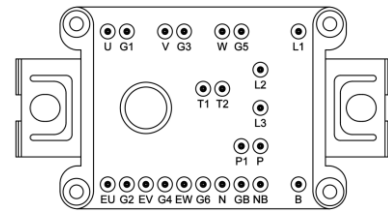

引脚示意图

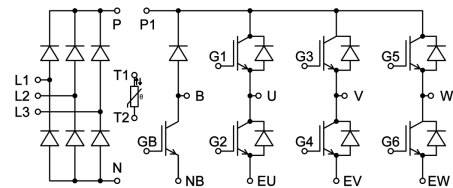

电路示意图

订货信息 ORDER MESSAGE

订货型号 Order codes	印记 Marking	封装 Package	包装 Packaging	器件重量 Device Weight
JT015N120F7PD1E	JT015N120F7PD1E	EasyPIM1B 模块	盒装	24g(typ)

绝对最大额定值 ABSOLUTE RATINGS ($T_c=25^\circ\text{C}$)

IGBT, 逆变器/制动、斩波 IGBT, Inverter/Brake-Chopper

项 目 Parameter	条件	符 号 Symbol	数 值 Value	单 位 Unit
最高集电极-发射极直流电压 Collector-Emmitter Voltage	$T_{vj}=25^\circ\text{C}$	V_{ces}	1200	V
连续集电极极电流 Collector Current-continuous	$T_c=100^\circ\text{C}, T_{vj}=150^\circ\text{C};$ $T_c=25^\circ\text{C}, T_{vj}=150^\circ\text{C}$	I_c	15 28	A
最大脉冲集电极极电流 (注1) Collector Current – pulse (note 1)	$t_p = 1 \text{ ms}$	I_{CM}	30	A
最高栅极发射极电压 Gate-Emmitter Voltage		V_{GES}	± 20	V
短路时间 short circuit time	$V_{GE}=15\text{V}, V_{CE}=600\text{V}$	t_{sc}	10	μs
耗散功率 Power Dissipation	$T_c=25^\circ\text{C}, T_{vj}=150^\circ\text{C}$	P_D	130	W
结温范围 Junction Temperature		T_{vjmax}	175	°C
		T_{vjop}	-40~+150	

二极管, 逆变器/FRD, Inverter

项 目 Parameter	条件	符 号 Symbol	数 值 Value	单 位 Unit
反向重复峰值电压 Repetitive peak reverse voltage	$T_{vj} = 25^\circ\text{C}$	V_{RRM}	1200	V
连续正向直流电流 Continuous DC forward current		I_F	15	A
正向重复峰值电流 Repetitive peak forward current	$t_p = 1 \text{ ms}$	I_{FRM}	30	A
I^2t -值 I^2t value	$V_R = 0 \text{ V}, t_p = 10$ $\text{ms}, T_{vj} = 150^\circ\text{C}$	I^2t	14	A^2S



绝对最大额定值 ABSOLUTE RATINGS ($T_c=25^\circ\text{C}$)

二极管, 整流器/Diode, Rectifier

项 目 Parameter	条 件	符 号 Symbol	数 值 Value	单 位 Unit
反向重复峰值电压 Repetitive peak reverse voltage	$T_{vj} = 25^\circ\text{C}$	V_{RRM}	1600	V
最大正向均方根电流(每芯片) Maximum RMS forward current per chip	$T_c=80^\circ\text{C}$	I_{FRMSM}	30	A
最大整流器输出均方根电流 Maximum RMS current at rectifier output	$T_c=80^\circ\text{C}$	I_{RMSM}	30	A
正向浪涌电流 Surge forward current	$t_p = 10 \text{ ms}, T_{vj} = 25^\circ\text{C}$ $t_p = 10 \text{ ms}, T_{vj} = 150^\circ\text{C}$	I_{FSM}	300 245	A
I^2t -值 I^2t value	$t_p = 10 \text{ ms}, T_{vj} = 25^\circ\text{C}$ $t_p = 10 \text{ ms}, T_{vj} = 150^\circ\text{C}$	I^2t	450 300	A^2S A^2S





电特性 ELECTRICAL CHARACTERISTICS
IGBT, 逆变器/制动、斩波 IGBT, Inverter/Brake-Chopper

项 目 Parameter	符 号 Symbol	测试条件 Tests conditions	最小 Min	典型 Typ	最大 Max	单位 Unit
关态特性 Off –Characteristics						
集电极-发射极击穿电压 Collector-Emmitter Voltage	BV_{CES}	$I_C=1mA, V_{GE}=0V$	1200	-	-	V
零栅压下集电极漏电流 Zero Gate Voltage Collector Current	I_{CES}	$V_{CE}=1200V, V_{GE}=0V,$ $T_C=25^{\circ}C$	-	-	1	mA
正向栅极体漏电流 Gate-body leakage current, forward	I_{GESF}	$V_{CE}=0V, V_{GE} =20V$	-	-	200	nA
反向栅极体漏电流 Gate-body leakage current, reverse	I_{GESR}	$V_{CE}=0V, V_{GE} =-20V$	-	-	-200	nA
通态特性 On-Characteristics						
阈值电压 Gate-Emmitter Threshold Voltage	$V_{GE(th)}$	$V_{CE} = V_{GE}, I_C=0.25mA$	5.3	5.9	6.5	V
饱和压降 Collector-Emmitter saturation Voltage	V_{CESAT}	$V_{GE}=15V, I_C=15A$ $T_C=25^{\circ}C$ $T_C=125^{\circ}C$ $T_C=150^{\circ}C$	- - -	1.8 2.15 2.25	2.3 - -	V
短路电流 (注2) Short Collector current (Note 2)	$I_{C(SC)}$	$V_{GE}=15V, V_{CE}=600V, t_{SC}$ $< 10\mu s T_C=25^{\circ}C$		75		A
动态特性 Dynamic Characteristics						
输入电容 Input capacitance	C_{ies}	$V_{CE}=25V,$ $V_{GE}=0V,$ $f=1.0MHz$	-	1.26		nF
输出电容 Output capacitance	C_{oes}		-	0.078		nF
反向传输电容 Reverse transfer capacitance	C_{res}		-	0.041		nF



电特性 ELECTRICAL CHARACTERISTICS

IGBT, 逆变器/制动、斩波 IGBT, Inverter/Brake-Chopper

项 目 Parameter	符 号 Symbol	测试条件 Tests conditions	最小 Min	典型 Typ	最大 Max	单位 Unit	
开关特性 Switching Characteristics							
开启延迟时间 Turn-On delay time	$t_d(\text{on})$	$V_{CC}=600V, I_c=15A, R_G=10\Omega, V_{GE}=15V$	$T_C=25^\circ\text{C}$	-	12	-	ns
上升时间 Turn-On rise time	t_r		$T_C=25^\circ\text{C}$	-	38	-	ns
关断延迟时间 Turn-Off delay time	$t_d(\text{off})$		$T_C=25^\circ\text{C}$	-	142	-	ns
下降时间 Turn-Off Fall time	t_f		$T_C=25^\circ\text{C}$	-	444	-	ns
开通损耗 Turn-On energy	E_{on}		$T_C=25^\circ\text{C}$	-	0.44	-	mJ
关断损耗 Turn-off energy	E_{off}		$T_C=25^\circ\text{C}$	-	1.47	-	mJ
总开关损耗 Total switching energy	E_{tot}		$T_C=25^\circ\text{C}$	-	1.91	-	mJ
开启延迟时间 Turn-On delay time	$t_d(\text{on})$	$V_{CC}=600V, I_c=15A, R_G=1\Omega, V_{GE}=15V, T_C=175^\circ\text{C}$	$T_C=175^\circ\text{C}$	-	14	-	ns
上升时间 Turn-On rise time	t_r		$T_C=175^\circ\text{C}$	-	50	-	ns
关断延迟时间 Turn-Off delay time	$t_d(\text{off})$		$T_C=175^\circ\text{C}$	-	148	-	ns
下降时间 Turn-Off Fall time	t_f		$T_C=175^\circ\text{C}$	-	710	-	ns
开通损耗 Turn-On energy	E_{on}		$T_C=175^\circ\text{C}$		0.66		mJ
关断损耗 Turn-off energy	E_{off}		$T_C=175^\circ\text{C}$		2.21		mJ
总开关损耗 Total switching energy	E_{tot}		$T_C=175^\circ\text{C}$		2.87		mJ
栅极电荷总量 Total Gate Charge	Q_g	$V_{GE}=-15V \dots +15V$	-	112	-	nC	
内部栅极电阻 Internal gate resistance	R_{Gint}	$f=1\text{ MHz, open collector}$		0.5		Ω	
结—外壳热阻 Thermal resistance junction to case	R_{thJC}	每个IGBT per IGBT		1.05	1.15	K/W	
外壳—散热器热阻 Thermal resistance case to heatsink	R_{thCH}	每个IGBT per IGBT $\lambda_{\text{Paste}} = 1\text{ W}/(\text{m}\cdot\text{K}) /$ $\lambda_{\text{grease}} = 1\text{ W}/(\text{m}\cdot\text{K})$		1.05		K/W	
开关下的温度 Temperature under switching conditions	T_{vjop}		-40		150	$^\circ\text{C}$	



电特性 ELECTRICAL CHARACTERISTICS

二极管, 逆变器/FRD, Inverter

项 目 Parameter	符 号 Symbol	测试条件 Tests conditions	最小 Min	典型 Typ	最大 Max	单位 Unit
二极管特性 Diode Characteristics						
正向压降 Drain-Source Diode Forward Voltage	V_F	$V_{GE}=0V, I_S=15A,$ $TC=25^{\circ}C$	-	1.85	2.3	V
		$V_{GE}=0V, I_S=15A,$ $TC=150^{\circ}C$	-	1.7	-	V
反向恢复时间 Diode Reverse recovery time	t_{rr}	$V_{GE}=0V, V_R=600V$ $I_F=15A$ $dI_F/dt=1000A/\mu s$ $TC=25^{\circ}C$	-	60	-	ns
反向恢复电荷 Diode Reverse recovery charge	Q_{rr}		-	700	-	nC
反向恢复电流 Diode Reverse recovery Current	I_{RRM}		-	25	-	A
结-外壳热阻 Thermal resistance junction to case	R_{thJC}	每个二极管 per diode		1.75	1.9	K/W
外壳-散热器热阻 Thermal resistance case to heatsink	R_{thCH}	每个二极管 per diode $\lambda_{Paste} = 1 W/(m \cdot K)$ / $\lambda_{grease} = 1 W/(m \cdot K)$		1.3		K/W
开关下的温度 Temperature under switching conditions	T_{vjop}		-40		150	$^{\circ}C$





电特性 ELECTRICAL CHARACTERISTICS

二极管，整流器/Diode, Rectifier

项 目 Parameter	符 号 Symbol	测试条件 Tests conditions	最小 Min	典型 Typ	最大 Max	单位 Unit
二极管特性 Diode Characteristics						
正向压降（芯片） Diode Forward Voltage	V_F	$V_{GE}=0V, I_F=15A$	-	0.85	-	V
反向电流 Reverse current	I_R	$T_{vj} = 150^{\circ}C,$ $V_R = 1600 V$		1		mA
结—外壳热阻 Thermal resistance junction to case	R_{thJC}	每个二极管 per diode		1.2	1.35	K/W
外壳—散热器热阻 Thermal resistance case to heatsink	R_{thCH}	每个二极管 per diode $\lambda_{Paste} = 1 W/(m \cdot K) /$ $\lambda_{grease} = 1 W/(m \cdot K)$		1.15		K/W

负温度系数热敏电阻/NTC-Thermistor

项 目 Parameter	符 号 Symbol	最小 Min	典型 Typ	最大 Max	单位 Unit	
额定电阻值 Rated resistance	$R_{25^{\circ}C}$	4.75	5	5.25	kohm	
时间常数 静止空气中	τ	-	-	10	Sec	
最大额定功率	P_{max}	-	-	10	mW	
B-值 B-value	$B = [(T_a \times T_b) / (T_b - T_a)] \times \ln(R_a / R_b)$ $T_b = 50^{\circ}C \pm 0.01^{\circ}C$	$B_{25/50}$	3346.2	3380	3413.8	K
工作温度	-	-50	-	200	$^{\circ}C$	

注释:

- 1: 脉冲宽度由最高结温限制
- 2: 两次短路之间的间隔大于 1 秒时，允许短路测试的次数最大为 1000 次

Notes:

- 1: Pulse width limited by maximum junction temperature
- 2: Allowed number of short circuits: <1000; time between short circuits: >1s.



模块特性/Module Characteristics

项 目 Parameter	符 号 Symbol	测试条件 Tests conditions	最小 Min	典型 Typ	最大 Max	单位 Unit
绝缘测试电压 Isolation test voltage	V_{ISOL}	RMS, f = 50 Hz, t = 1min		2.5		KV
模块基板材料 Material of module baseplate	Cu					
内部绝缘 Internal isolation	基本绝缘 (class 1, IEC 61140) Basic insulation (class1, IEC 61140)		Al ₂ O ₃			
爬电距离 Creepage distance		端子-散热片 terminal to heatsink	-	11.5	-	mm
		端子-端子 Terminal to terminal	-	6.3	-	
电气间隙 Clearance		端子-散热片 terminal to heatsink	-	10	-	mm
		端子-端子 Terminal to terminal	-	5	-	
相对电痕指数 Comperative tracking index	CT1		200			
杂散电感,模块 Stray inductance module	L_{sCE}			30		nH
模块引线电阻,端子-芯片 Module lead resistance terminals chip	$R_{CC'+EE'}$			8		mΩ
储存温度 Storage temperature	T_{stg}		-40		125	°C
安装力 Anpresskraft fur mech. Bef. pro Feder mountig force per clamp	F		20		50	N
重量 Weight			-	24	-	g



特征曲线 ELECTRICAL CHARACTERISTICS (curves)

IGBT Typical Output Characteristics(Tvj=25°C)

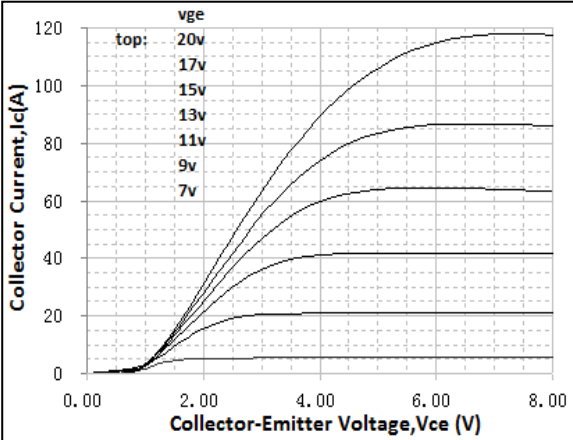

IGBT Typical Output Characteristics(Tvj=175°C)

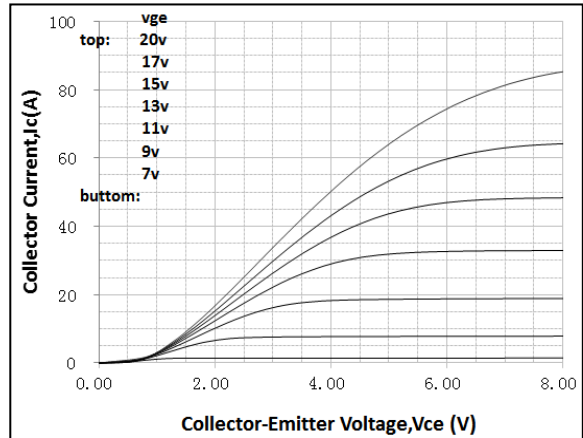

IGBT Transfer characteristic VCE=20V

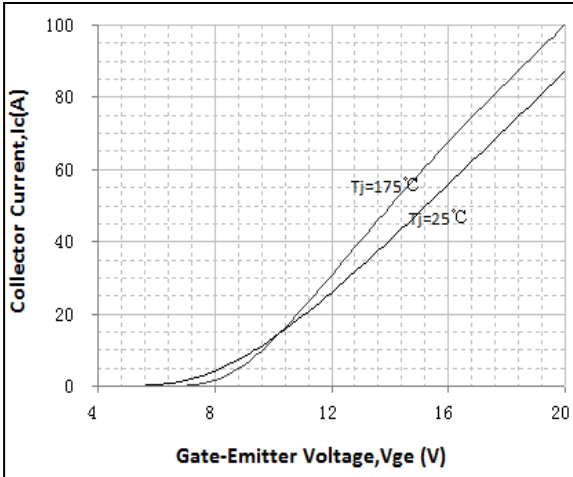

IGBT Vcesat vs. Tj

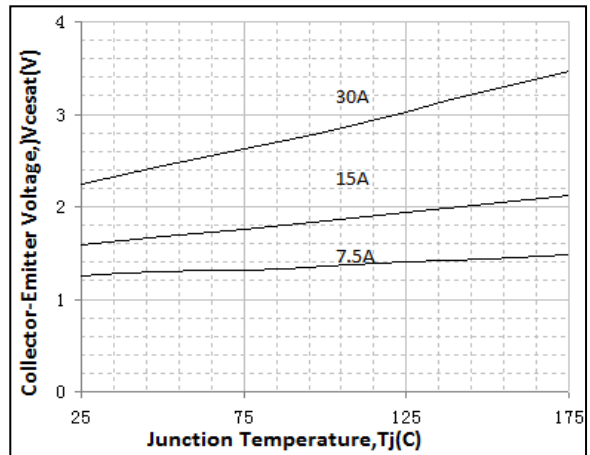

IGBT Switching Loss vs. Tj

VGE=15V, VCE=600V, IC=15A, Rg=10Ω

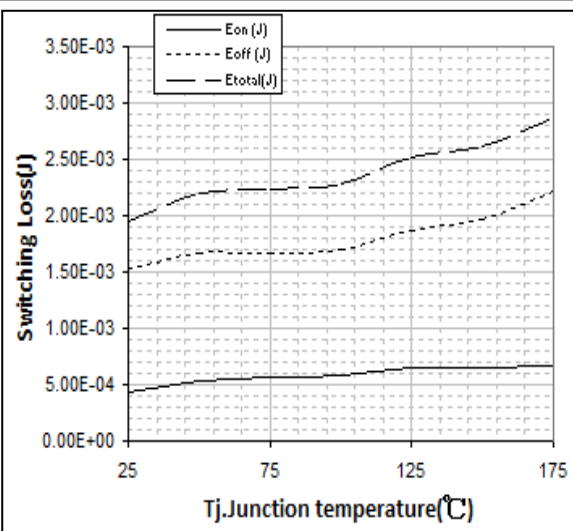

IGBT Switching Loss vs. IC(25°C)

VGE=15V, VCE=600V, Rg=10Ω

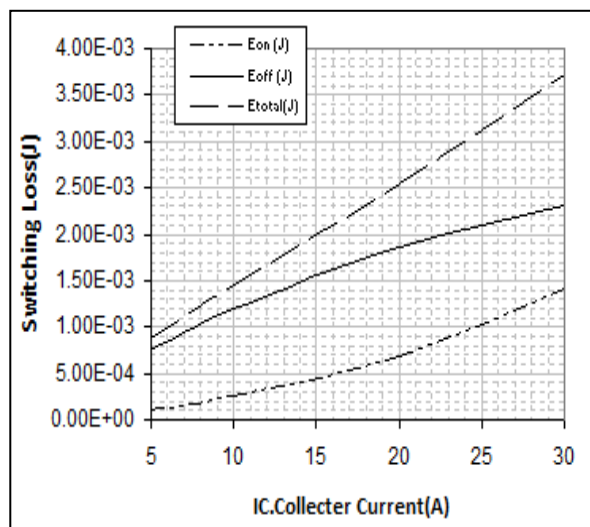



**Inverter FRD
Forward Characteristics**

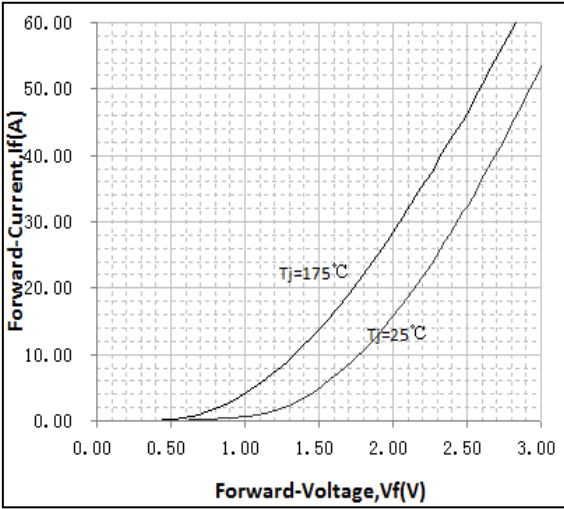

RBSOA of IGBT

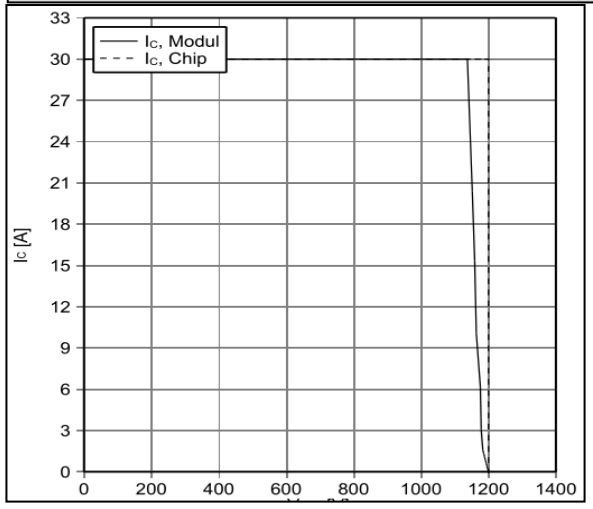

**Transient Thermal Impedance
(Inverter/Brake-chooper IGBT)**

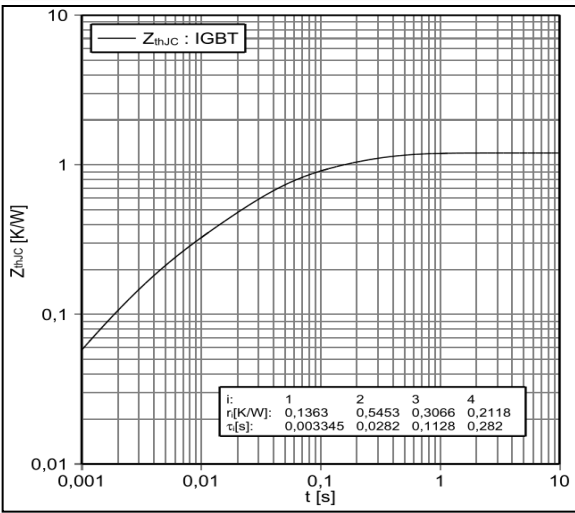

**Transient Thermal Impedance
(Inverter/Brake-chooper FRD)**

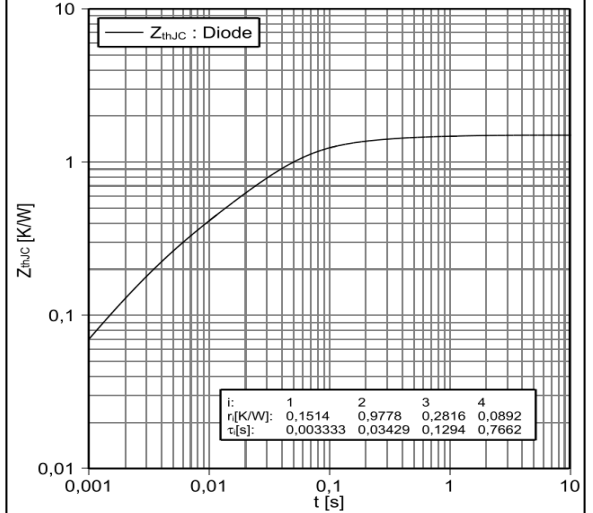

**Rectifier Diode
Transient Thermal Impedance**

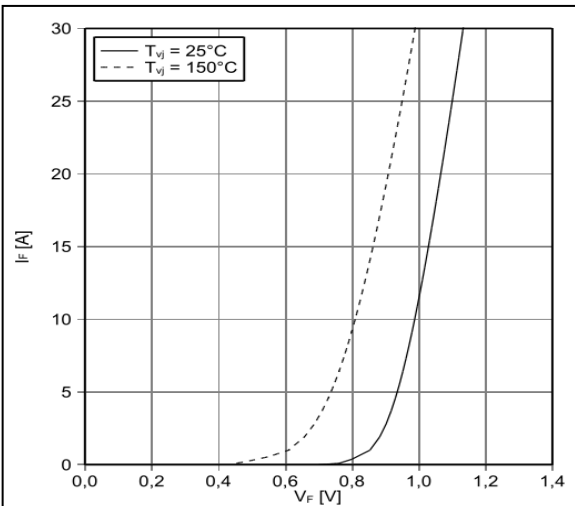

**NTC-Thermistor-temperature
characteristic(typical)**

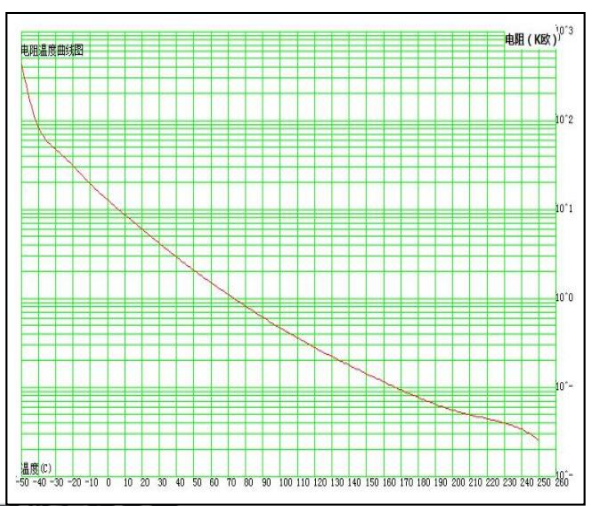



外形尺寸 PACKAGE MECHANICAL DATA
Circuit diagram

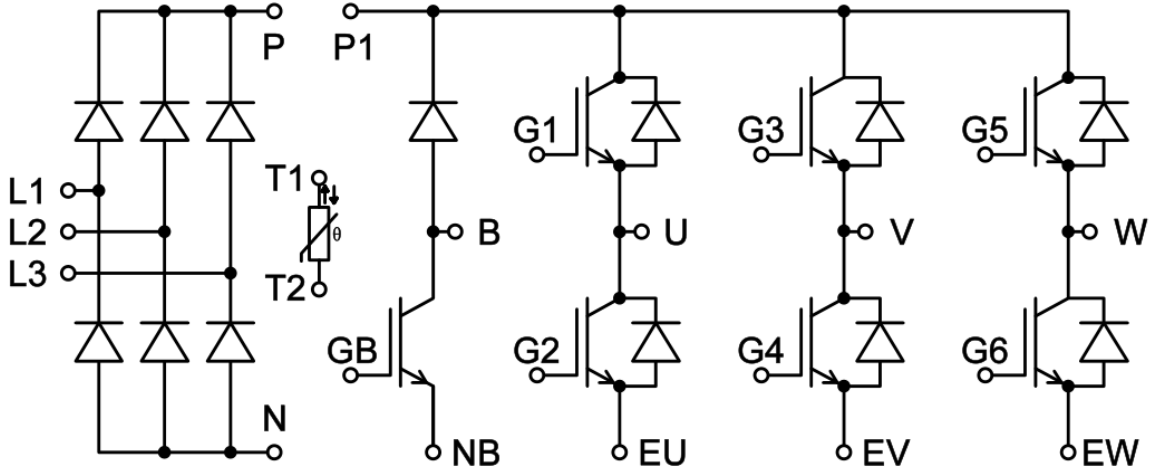

Package outlines

单位 Unit: mm

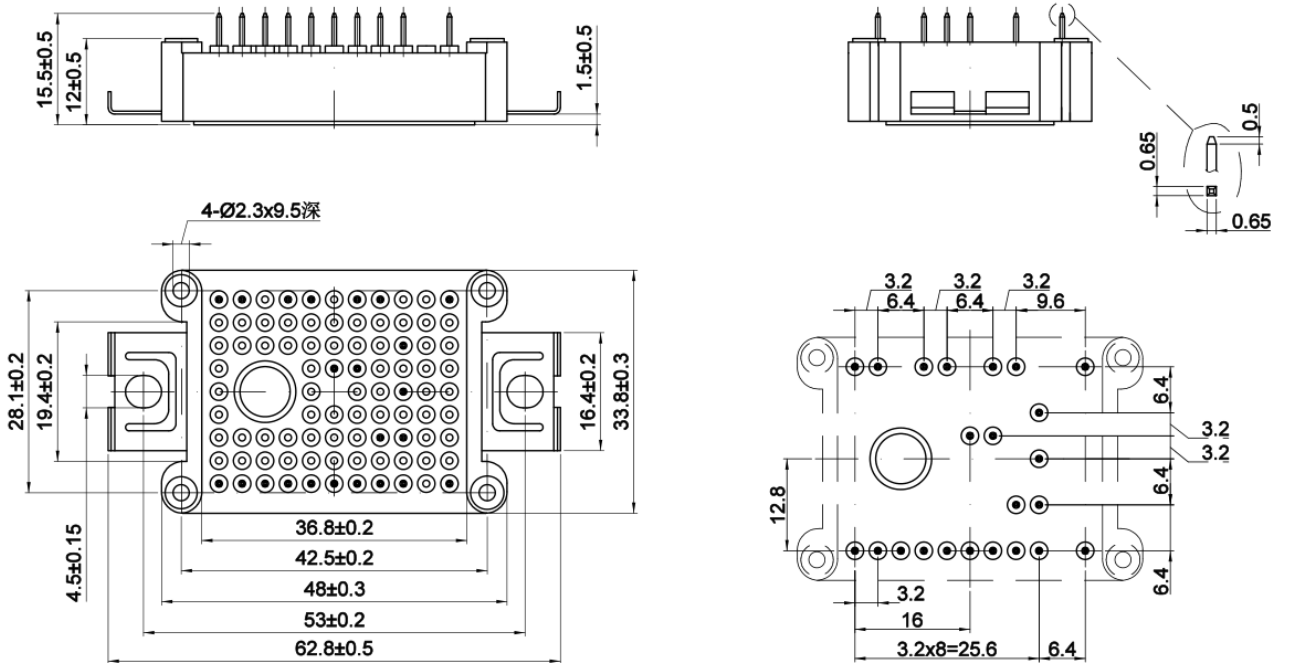



注意事项

1. 吉林华微电子股份有限公司的产品销售分为直销和销售代理，无论哪种方式，订货时请与公司核实。
2. 购买时请认清公司商标，如有疑问请与公司本部联系。
3. 在电路设计时请不要超过器件的绝对最大额定值，否则会影响整机的可靠性。
4. 本说明书如有版本变更不另外告知。

NOTE

1. Jilin Sino-microelectronics co., Ltd sales its product either through direct sales or sales agent , thus, for customers, when ordering , please check with our company.
2. We strongly recommend customers check carefully on the trademark when buying our product, if there is any question, please don't be hesitate to contact us.
3. Please do not exceed the absolute maximum ratings of the device when circuit designing.
4. Jilin Sino-microelectronics co., Ltd reserves the right to make changes in this. specification sheet and is subject to change without prior notice.

联系方式

吉林华微电子股份有限公司

公司地址：吉林省吉林市深圳街 99 号

邮编：132013

总机：86-432-64678411

传真：86-432-64665812

网址：www.hwdz.com.cn

CONTACT

JILIN SINO-MICROELECTRONICS CO., LTD.

ADD: No.99 Shenzhen Street, Jilin City, Jilin Province, China.

Post Code: 132013

Tel: 86-432-64678411

Fax: 86-432-64665812

Web Site: www.hwdz.com.cn