



TT075K065FQ

主要参数 MAIN CHARACTERISTICS

I _c	75A
V _{CE}	650V
V _{cesat-typ}	1.7V

用途

- PFC
- 储能
- 光伏

APPLICATIONS

- Power factor corrector (PFC)
- Energy Storage
- photovoltaic

产品特性

- 低栅极电荷
- Trench FS 技术
- RoHS 产品
- 快开关速度
- 低开关损耗
- V_{CE(sat)}正温度系数

FEATURES

- Low gate charge
- Trench FS Technology
- RoHS product
- Fast switching speed
- Low switching losses
- V_{CE(sat)} with positive temperature coefficient

封装 Package

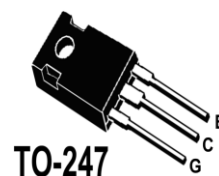
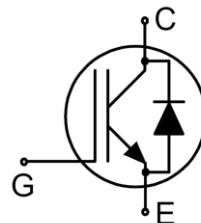

订货信息 ORDER MESSAGE

订货型号 Order codes	印记 Marking	封装 Package
无卤-条管 Halogen-Free-Tube		
TT075K065FQ-GE-BR	TT075K065FQ	TO-247

绝对最大额定值 ABSOLUTE RATINGS ($T_c=25^\circ\text{C}$)

项 目 Parameter	符 号 Symbol	数 值 Value	单 位 Unit
最高集电极—发射极直流电压 Collector-emitter voltage	V_{CE}	650	V
*连续集电极电流 Collector current-continuous	I_C	80($T_c=25^\circ\text{C}$)	A
		75($T_c=100^\circ\text{C}$)	A
最大脉冲集电极极电流 (注1) Collector current – pulse (note 1)	I_{CM}	300	A
*二极管正向测试电流 Diode RMS forward current	I_F	80 ($T_c=25^\circ\text{C}$)	A
		75($T_c=100^\circ\text{C}$)	A
二极管正向不重复峰值电流 (浪涌电流) Surge non repetitive forward current $t_p=10\text{ ms}$ sinusoidal	I_{FSM}	300	A
最高栅极发射极电压 Gate-emitter voltage	V_{GE}	± 20	V
瞬态栅极发射极电压 Transient gate-emitter voltage ($t_p \leq 10\mu\text{s}$, $D < 0.010$)	V_{GE}	± 30	V
安全工作区 Turn-off safe area $V_{CE} \leq 650\text{V}$, $T_{vj} \leq 175^\circ\text{C}$, $t_p=1\mu\text{s}$	-	300	A
耗散功率 Power dissipation	P_D $T_c=25^\circ\text{C}$ P_D $T_c=100^\circ\text{C}$	395	W
		197	
工作结温 (注2) Operating junction temperature range	T_{VJ}	$-40 \sim +175$	$^\circ\text{C}$
存储温度 Storage temperature	T_{STG}	$-55 \sim +150$	$^\circ\text{C}$
引线最高焊接温度 Maximum lead temperature for soldering purposes	T_L	260	$^\circ\text{C}$

*连续集电极电流由最高结温限制。

*Collector current limited by maximum junction temperature.,and $T_c=25^\circ\text{C}$ limited by bondwire.

For optimum lifetime and reliability, JSMC recommends operating conditions that do not exceed 80% of the maximum ratings stated in this datasheet

注释:

1: 脉冲宽度由最高结温限制。

2: 过载工况时, 允许在最高结温 $T_{vjop}=175^\circ\text{C}$ 下运行, 最大占空比 $<20\%$ (最多持续 60s)

Notes:

1: Pulse width limited by maximum junction temperature.

2: Under overload condition, it is allowed to operate at the maximum junction temperature $T_{vjop}=175^\circ\text{C}$, and the maximum duty ratio is less than 20% (lasting for 60 s at most)



电特性 ELECTRICAL CHARACTERISTICS

项 目 Parameter	符 号 Symbol	测试条件 Tests conditions	最小 Min	典型 Typ	最大 Max	单位 Units
关态特性 Off –Characteristics						
集电极—发射极击穿电压 Collector-emitter voltage	BV_{CES}	$I_C=250\mu A, V_{GE}=0V$	650	-	-	V
零栅压下集电极漏电流 Zero gate voltage collector current	I_{CES}	$V_{CE}=650V, V_{GE}=0V, T_{vj}=25^\circ C$	-	-	80	μA
正向栅极体漏电流 Gate-body leakage current,forward	I_{GESF}	$V_{CE}=0V, V_{GE}=20V, T_{vj}=25^\circ C$	-	-	200	nA
反向栅极体漏电流 Gate-body leakage current,reverse	I_{GESR}	$V_{CE}=0V, V_{GE}=-20V, T_{vj}=25^\circ C$	-	-	-200	nA
通态特性 On-Characteristics						
阈值电压 Gate threshold voltage	$V_{GE(th)}$	$V_{CE} = V_{GE}, I_C=0.75mA$	4.5		6.5	V
饱和压降 Collector-emitter saturation voltage	V_{CESAT}	$V_{GE}=15V, I_C=75A$ $T_{vj}=25^\circ C$ $T_{vj}=150^\circ C$	- -	1.7 2.2	2.1 -	V
动态特性 Dynamic Characteristics						
输入电容 Input capacitance	C_{ies}	$V_{CE}=25V$ $V_{GE}=0V$ $f=1.0MHz$	-	4118	-	pF
输出电容 Output capacitance	C_{oes}		-	328	-	pF
反向传输电容 Reverse transfer capacitance	C_{res}		-	52	-	pF
栅极电荷总量 Total gate charge	Q_g		-	155	-	nC
栅极-发射极 Gate to emitter charge	Q_{ge}	$V_{CC}=520V, I_C=75A, V_{GE}=15V$	-	42	-	
栅极-集电极 Gate to collector charge	Q_{gc}		-	62	-	



电特性 ELECTRICAL CHARACTERISTICS

开关特性 Switching Characteristics

项 目 Parameter	符 号 Symbol	测试条件 Tests conditions	最小 Min	典型 Typ	最大 Max	单位 Units
开启延迟时间 Turn-on delay time	$t_{d(on)}$	$V_{CC}=400V, I_c=75A, R_G=10\Omega$ $V_{GE}=15V$ $T_{vj}=25^\circ C$	-	38	-	ns
上升时间 Turn-on rise time	t_r		-	106	-	ns
关断延迟时间 Turn-off delay time	$t_{d(off)}$		-	148	-	ns
下降时间 Turn-off fall time	t_f		-	88	-	ns
开通损耗 Turn-on energy	Eon		-	2.27	-	mJ
关断损耗 Turn-off energy	Eoff		-	2.03	-	mJ
总开关损耗 Total switching energy	Etot		-	4.30	-	mJ
开启延迟时间 Turn-on delay time	$t_{d(on)}$	$V_{CC}=400V, I_c=75A, R_G=10\Omega$ $V_{GE}=15V$ $T_{vj}=150^\circ C$	-	36	-	ns
上升时间 Turn-on rise time	t_r		-	106	-	ns
关断延迟时间 Turn-off delay time	$t_{d(off)}$		-	164	-	ns
下降时间 Turn-off fall time	t_f		-	120	-	ns
开通损耗 Turn-on energy	Eon		-	2.43	-	mJ
关断损耗 Turn-off energy	Eoff		-	2.30	-	mJ
总开关损耗 Total switching energy	Etot		-	4.73	-	mJ

反并联二极管特性及最大额定值 Anti-Parallel Diode Characteristics and Maximum Ratings

正向压降 Diode forward voltage	V_F	$I_F=75A, T_{vj}=25^\circ C$ $T_{vj}=150^\circ C$	-	1.45	1.8	V
反向恢复时间 Reverse recovery time	t_{rr}	$V_R=200V, I_F=75A$ $dI_F/dt=200A/\mu s$ $T_{vj}=25^\circ C$	-	152	-	ns
反向恢复电荷 Diode reverse recovery charge	Q_{rr}		-	748	-	nC
反向恢复电流 Diode reverse recovery current	I_{rrm}		-	9.2	-	A
反向恢复时间 Diode reverse recovery time	t_{rr}	$V_R=200V, I_F=75A$ $dI_F/dt=200A/\mu s$ $T_{vj}=150^\circ C$	-	240	-	ns
反向恢复电荷 Diode reverse recovery charge	Q_{rr}		-	3.0	-	μC
反向恢复电流 Diode reverse recovery current	I_{rrm}		-	18	-	A

项 目 Parameter	符 号 Symbol	MAX	单 位 Unit
结到管壳的热阻 Junction to case IGBT	$R_{th(j-c)}$	0.38	$^\circ C/W$
结到管壳的热阻 Junction to case Diode	$R_{th(j-c)}$	0.55	$^\circ C/W$
结到环境的热阻 Junction to ambient	$R_{th(j-a)}$	40	$^\circ C/W$





特征曲线 ELECTRICAL CHARACTERISTICS (curves)

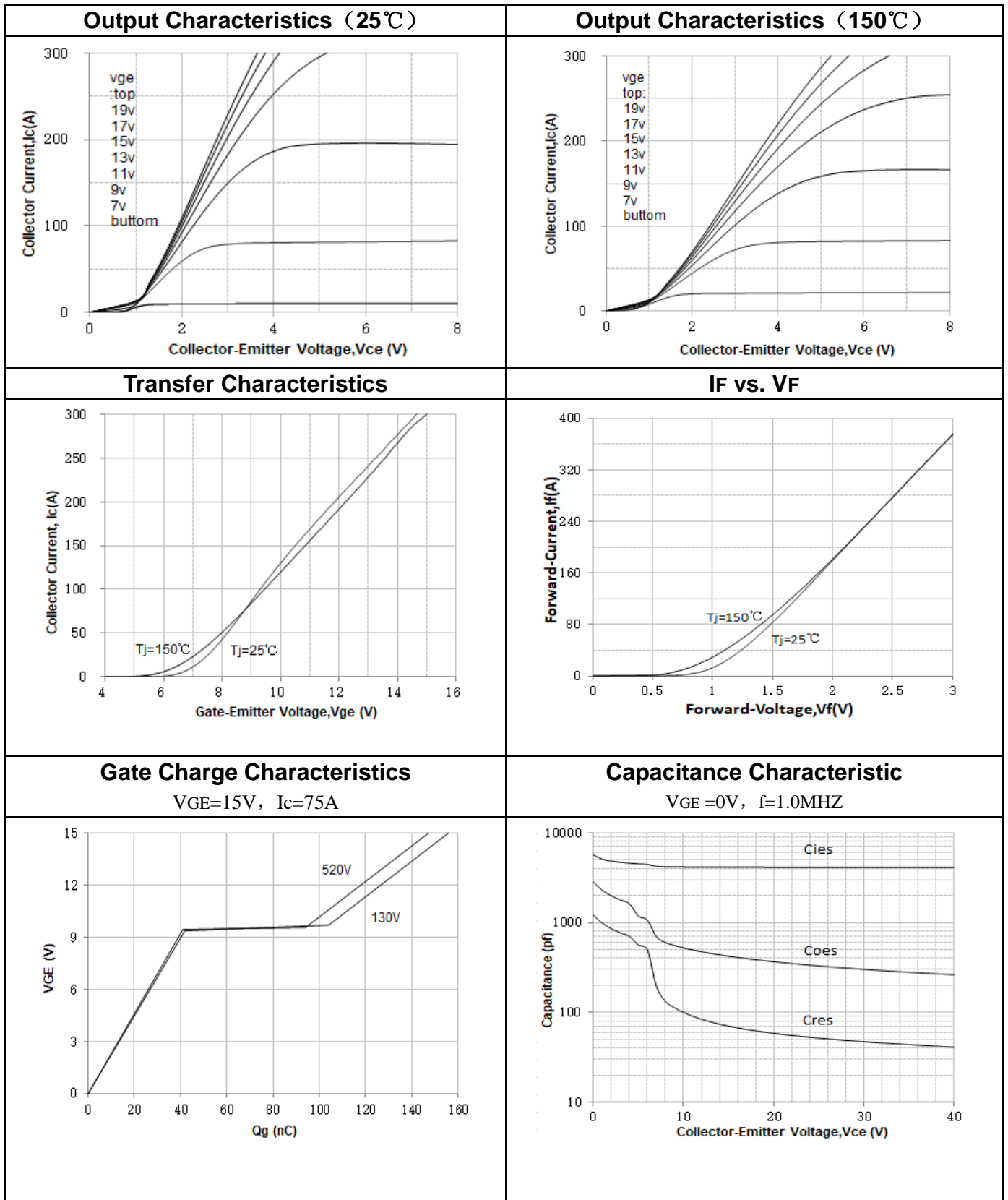



V_{CE}SAT vs. T_j

V_{GE}=15V, I_c=37.5A, 75A, 150A

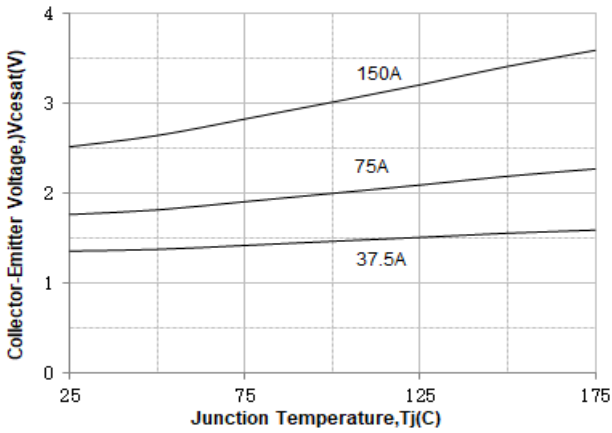

Switching Time vs. T_j

V_{GE}=15V, V_{CE}=400V, I_c=75A, R_G=10Ω

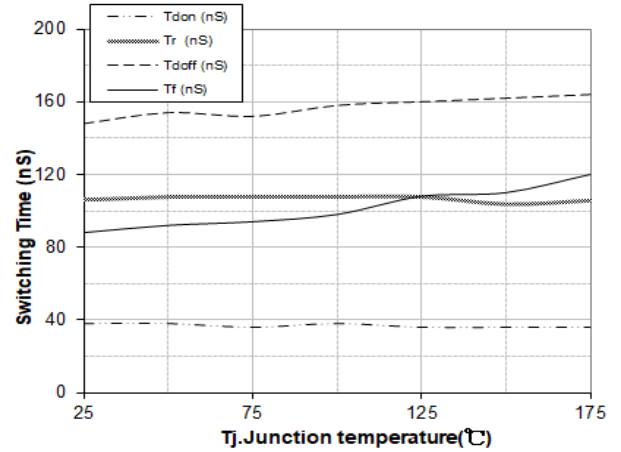

Switching Time vs. R_G(150°C)

V_{GE}=15V, V_{CE}=400V, I_c=75A

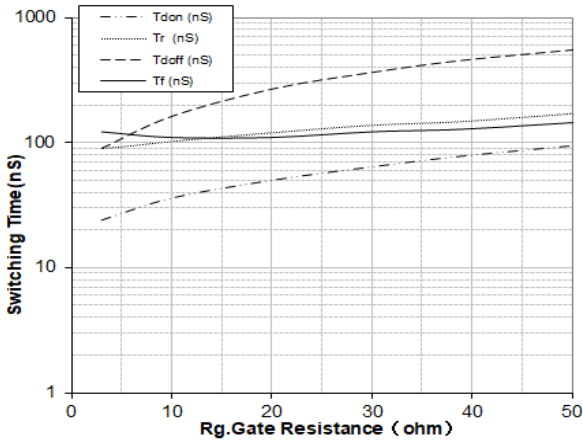

Switching Time vs. I_c(150°C)

V_{CE}=400V, V_{GE}=15V, R_G=10Ω

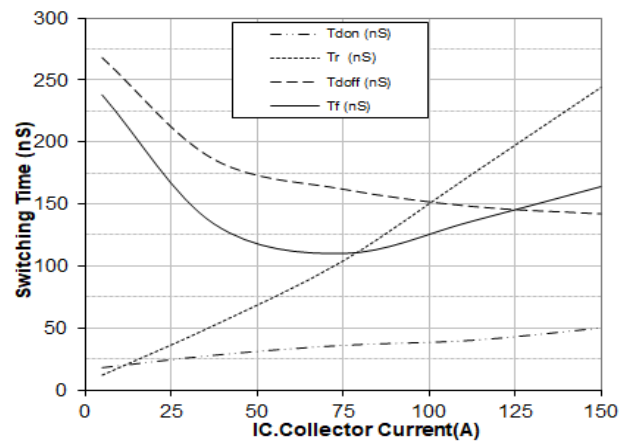

Switching Loss vs. T_j

V_{GE}=15V, V_{CE}=400V, I_c=75A, R_G=10Ω

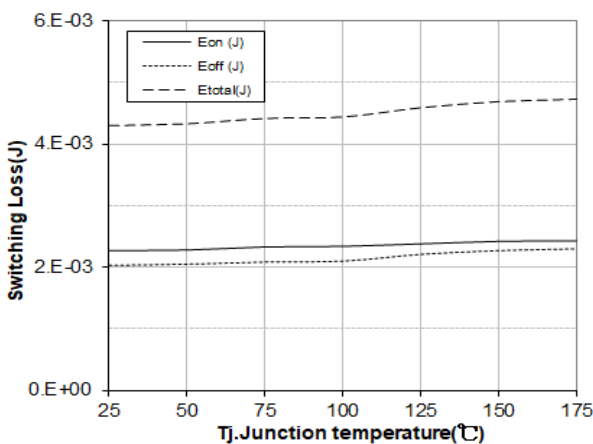

Switching Loss vs. R_G(150°C)

V_{GE}=15V, V_{CE}=400V, I_c=75A

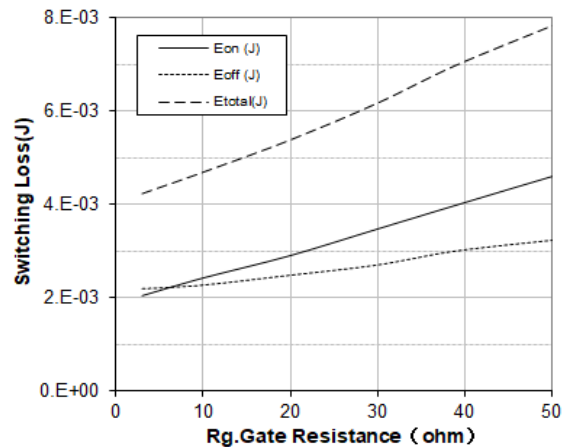



Switching Loss vs. V_{CE}(150°C)

V_{GE}=15V, I_c=75A, R_G=10Ω

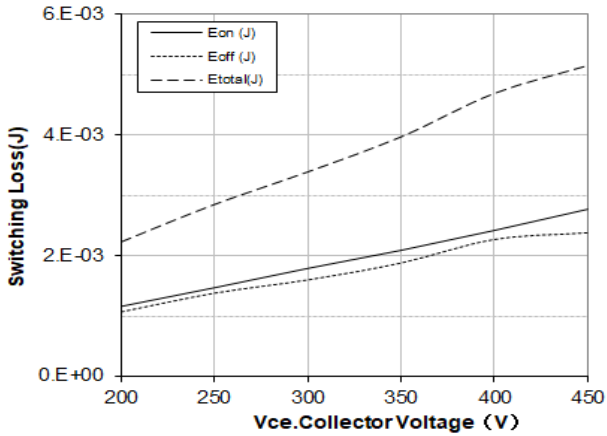

Collector current vs. Case temperature

V_{GE}≥15V, T_{vj}≤175°C

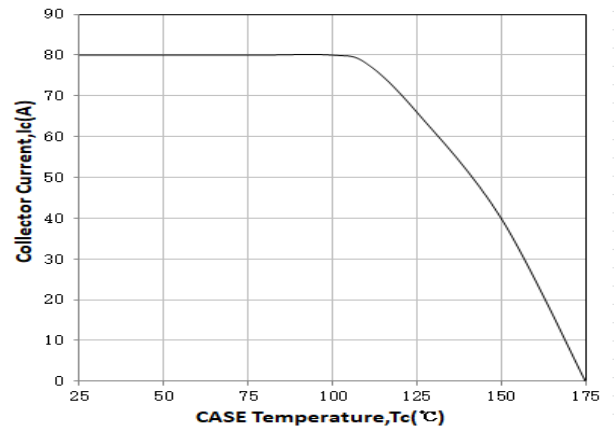

Transient Thermal Impedance for IGBT

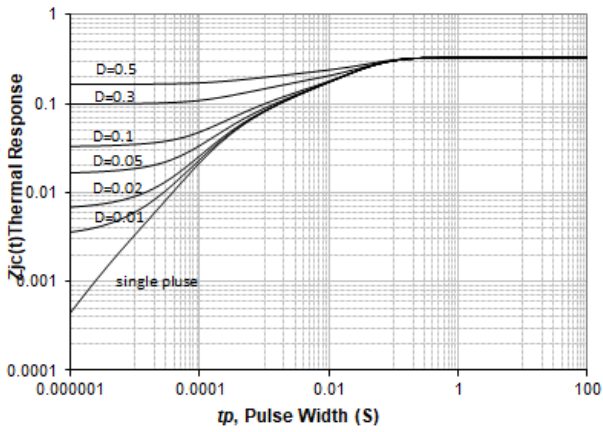

Forward Bias Safe Operating Area

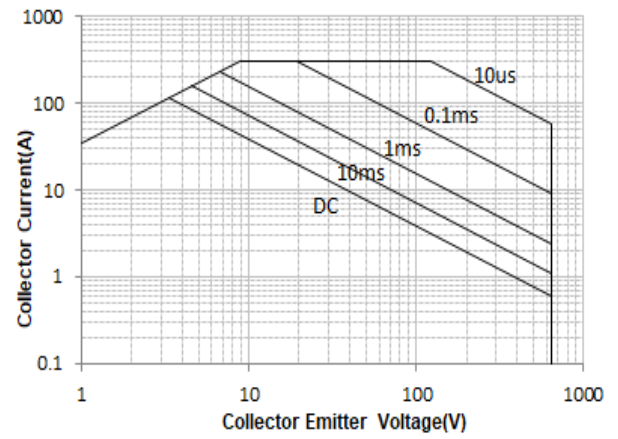



外形尺寸 PACKAGE MECHANICAL DATA

TO-247

单位 Unit: mm

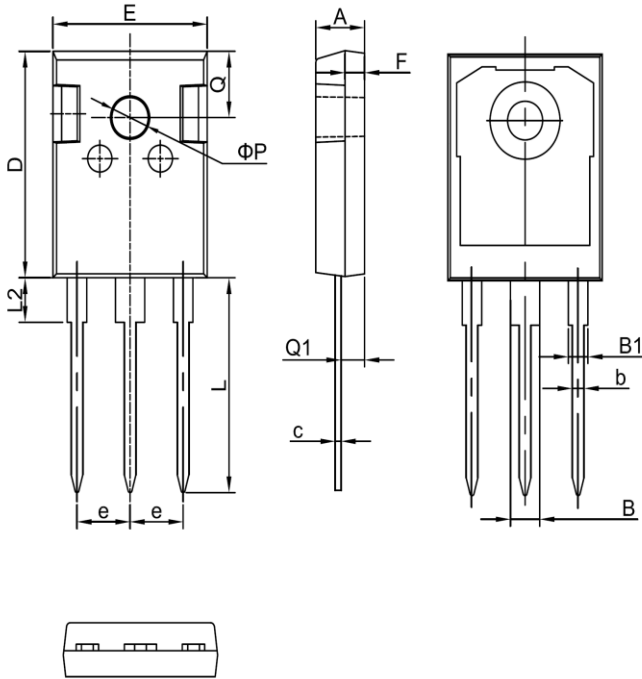

符号 symbol	MIN	MAX
A	4.90	5.10
B	2.95	3.35
B1	1.95	2.35
b	1.15	1.35
c	0.50	0.70
D	20.90	21.10
E	15.70	15.90
e	5.34	5.54
F	1.90	2.10
L	19.40	20.40
L2	4.03	4.23
Q	6.00	6.40
Q1	2.30	2.50
P	3.50	3.70



1. 吉林华微电子股份有限公司的产品销售分为直销和销售代理，无论哪种方式，订货时请与公司核实。
2. 购买时请认清公司商标，如有疑问请与公司本部联系。
3. 在电路设计时请不要超过器件的绝对最大额定值，否则会影响整机的可靠性。
4. 本说明书如有版本变更不另外告知。

NOTE

1. Jilin Sino-microelectronics co., Ltd sales its product either through direct sales or sales agent , thus, for customers, when ordering , please check with our company.
2. We strongly recommend customers check carefully on the trademark when buying our product, if there is any question, please don't be hesitate to contact us.
3. Please do not exceed the absolute maximum ratings of the device when circuit designing.
4. Jilin Sino-microelectronics co., Ltd reserves the right to make changes in this. specification sheet and is subject to change without prior notice.

联系方式

吉林华微电子股份有限公司

公司地址：吉林省吉林市深圳街 99 号

邮编：132013

总机：86-432-64678411

传真：86-432-64665812

网址：www.hwdz.com.cn

CONTACT

JILIN SINO-MICROELECTRONICS CO., LTD.

ADD: No.99 Shenzhen Street, Jilin City, Jilin Province, China.

Post Code: 132013

Tel: 86-432-64678411

Fax: 86-432-64665812

Web Site: www.hwdz.com.cn